



Smart Node
Discover the Joy of Smart Living

smartnode.in

CURTAIN FLOW

INSTRUCTION MANUAL

VERSION NO. : V.01.0524





CURTAIN FLOW

OVERVIEW

The Smart curtain motor by Smart Node is a modern solution that makes it easy to open and close the curtains at home or work. It works well with the SmartNode application, so one can control the curtains using your phone or remote.

Note that the actual product may differ from the drawings and illustrations in this instruction manual; they are provided primarily for reference.

TRACK ASSEMBLY

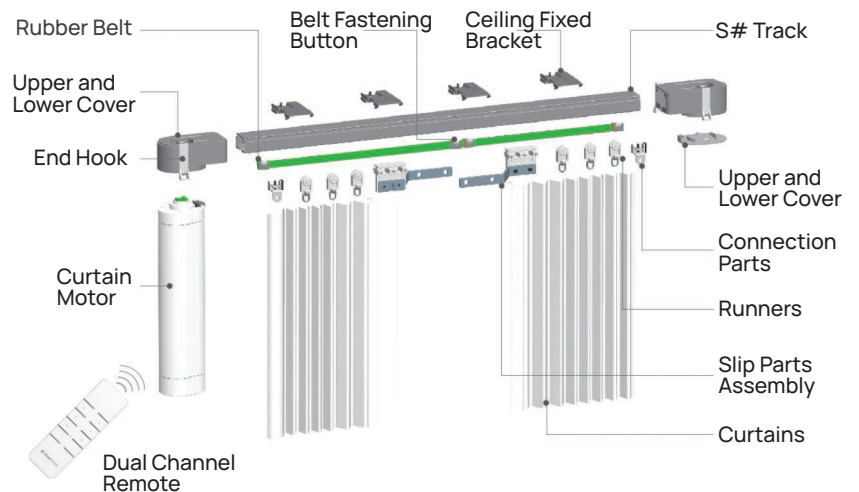

ONE SIDE OPEN OR CENTER OPEN

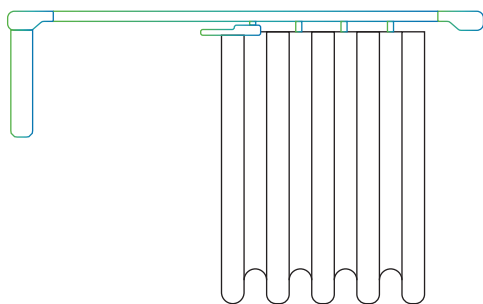

ONE SIDE OPEN
(RIGHT SIDE OR LEFT SIDE)

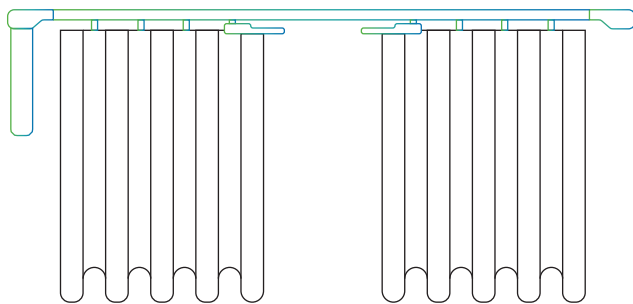

CENTER OPEN



WIRING KITS



LOAD

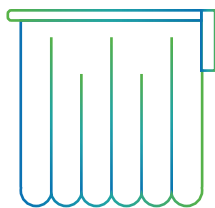

Safe Curtain Weight

50Kg

CONTROL FOR REMOTE (DUAL CHANNEL)



CHANNEL 1

CHANNEL 2



Open



Pause



Close

Power	3V 1 unit
Battery usage life	> 3 years
Transmitter distance	Outdoor 200 Meters Indoor 35 Meters
Controller frequency	433.92 MHz
Controller power	10mW

Up to 16 channels possible

TECHNICAL SPECIFICATION AND CONFIGURATION

Curtain motor dimensions

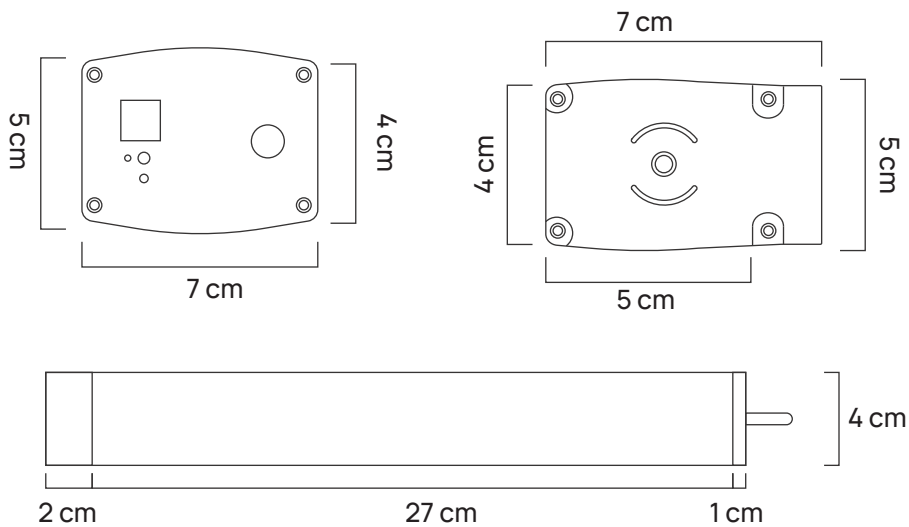

Curtain motor connections

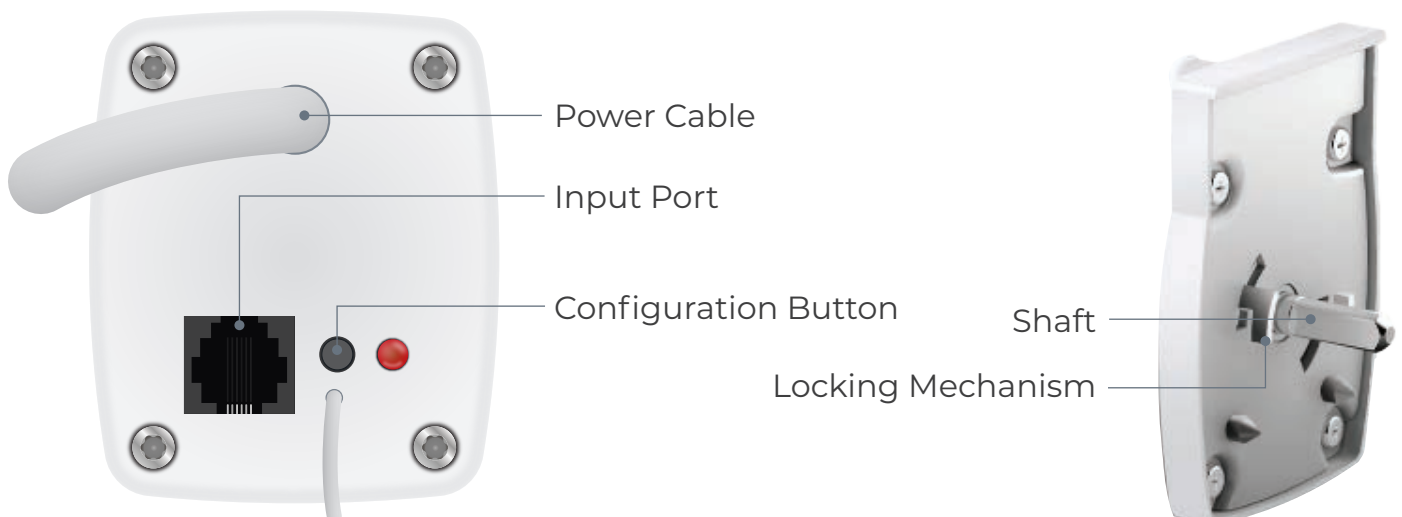

TAP ON BUTTON TO LEARN MORE

HOW TO CONFIGURE
THE CURTAIN FLOW ON WIFI

HOW TO ADD A CURTAIN
FLOW SWITCH TO APPLICATION

HOW TO LEARN REMOTE ?



Smart Node
Discover the Joy of Smart Living

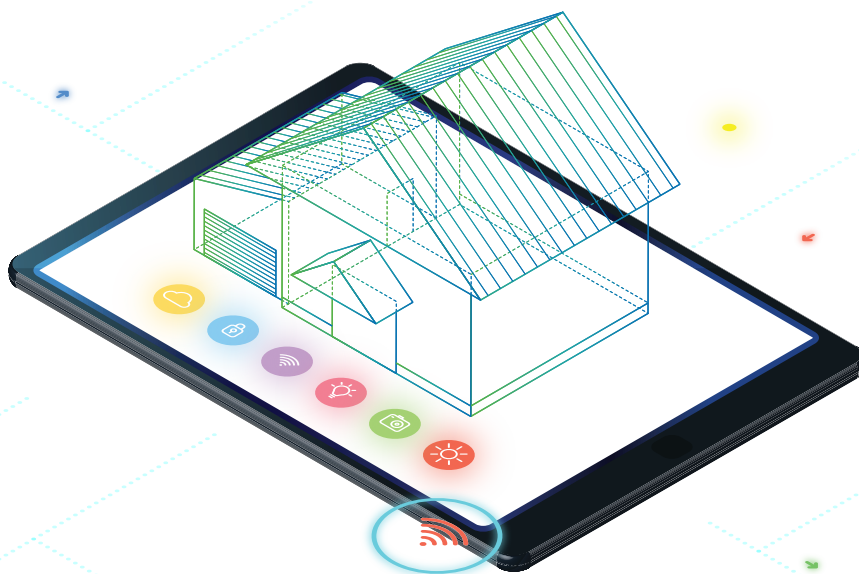

FOR SUPPORT CONTACT US ON
+91 93279 58743 | +91 93279 58744