

RGBW Controller

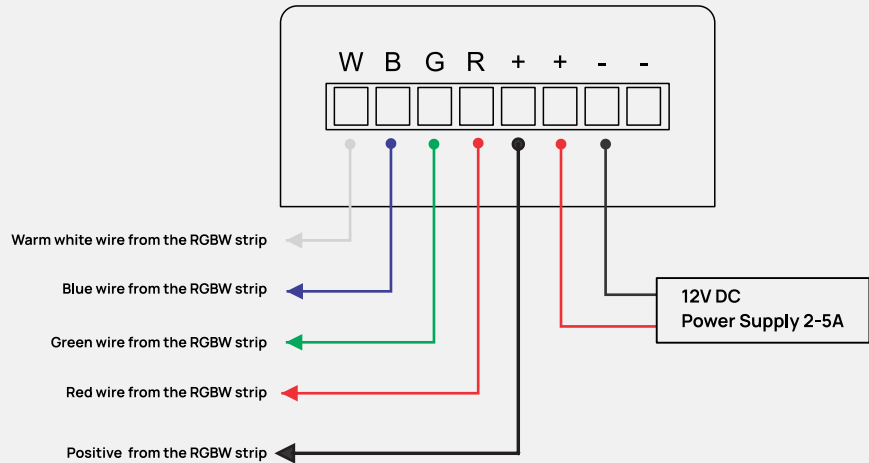





SD.RGBW.1



Technical Attributes

Connect way	RGB/RGBW LED strip
Mode of operation	Voice, Mobile app
Outout channel	RGB or RGBW
Input voltage	12VDC / 24VDC
Software	Android and iOS
Material	ABS
Color	White
Product dimensions	70mm x 52mm x 25mm
Product weight	66gms
Operating voltage	12 VDC / 24 VDC 2-5A
Max.support	5m
Mounting	Mounting in wall
Operating temperature	0°C - 65°C non condense
Shock proof	No
Water resistance	No
Warranty	5 Years
Connect method	Common anode

Features

	Internet independent scheduling
	16 Million colors selection
	Predefine patterns
	Brightness intensity control
	Pattern color selection
	Pattern speed management
	Tunable option